

# Direct Measurement of Electromagnetic Thrust of Electrodeless Helicon Plasma Thruster Using Magnetic Nozzle

Takahiro Nakamura, Kenji Takahashi, Hiroyuki Nishida, Shunjiro Shinohara, Takeshi Matsuoka, Ikkoh Funaki, Takao Tanikawa, and Tohru Hada

**Abstract**—In order to realize long-lived electric propulsion systems, we have been investigating an electrodeless plasma thruster. In our concept, a helicon plasma is accelerated by the magnetic nozzle for the thrusts production. In addition, the electromagnetic thrust can be enhanced by the additional radio-frequency rotating electric field (REF) power in the magnetic nozzle. In this study, a direct measurement of the electromagnetic thrust and a probe measurement have been conducted using a laboratory model of the thruster under the condition without the REF power input. From thrust measurement, it is shown that the thruster produces a sub-milli-newton order electromagnetic thrust force without the additional REF power. The thrust force and the density jump are observed due to the discharge mode transition from the inductive coupled plasma to the helicon wave excited plasma. The thermal thrust is theoretically estimated, and the total thrust force, which is a sum of the electromagnetic and the thermal thrust force and specific impulse are calculated to be up to 650  $\mu\text{N}$  (plasma production power of 400 W, Ar gas mass flow rate of 1.0 mg/s) and 210 s (plasma production power of 400 W, Ar gas mass flow rate of 0.2 mg/s), respectively.

**Keywords**—Electric propulsion, Helicon plasma, Lissajous acceleration, Thrust stand.

T. Nakamura is with the Graduate School of Engineering, Mechanical Systems Engineering, Tokyo University of Agriculture and Technology, Koganei, Tokyo, Japan (phone: +81-42-388-7078; fax: +81-42-388-7078; e-mail: 50012833007@st.tuat.ac.jp).

K. Takahashi is with the Graduate School of Engineering, Mechanical Systems Engineering, Tokyo University of Agriculture and Technology, Koganei, Tokyo, Japan (e-mail: 50011643040@st.tuat.ac.jp).

H. Nishida is with the Division of Advanced Mechanical Systems, Engineering, Institute of Engineering, Tokyo University of Agriculture and Technology, Koganei, Tokyo, Japan (e-mail: hnishida@cc.tuat.ac.jp).

S. Shinohara is with the Division of Advanced Mechanical Systems, Engineering, Institute of Engineering, Tokyo University of Agriculture and Technology, Koganei, Tokyo, Japan (e-mail: sshinoha@cc.tuat.ac.jp).

T. Matsuoka is with the Department of Space Flight Systems, Institute of Space and Astronautical Science, Sagami-hara, Kanagawa, Japan (e-mail: takeshi.matsuoka1@gmail.com).

I. Funaki is with the Department of Space Flight Systems, Institute of Space and Astronautical Science, Sagami-hara, Kanagawa, Japan (e-mail: funaki@isas.jaxa.jp).

T. Tanikawa is with the Institute of Science and Technology, Tokai University, Hiratsuka, Kanagawa, Japan (e-mail: tmth@keyaki.cc.u-tokai.ac.jp).

T. Hada is with the Department of Earth System Science and Technology, Interdisciplinary Graduate School of Engineering Sciences, Kyushu University, Kasuga, Fukuoka, Japan (e-mail: hada@kyushu-u.ac.jp).

## I. INTRODUCTION

ELECTRIC propulsion systems are suitable for a long-time space mission such as an interplanetary flight, and satellite attitude control system because of their high specific impulse, which can reduce the propellant consumption. The Japanese asteroid explorer “Hayabusa” has four ion engines, which are one of the electric propulsion systems, and the mission has been successfully accomplished [1]. In the next-generation space exploration such as a manned exploration to the Mars, a high power and a high efficiency electric propulsion system is one of promising propulsion systems as a main thruster. However, conventional electric propulsion systems have some problems on the lifetime, especially in high power operation, due to electrode erosion and contamination, which are caused by contacts between electrodes and the plasma.

The electrodeless plasma thruster, in which the electrodes do not contact with the plasma directly, is one of promising solutions for these problems [2]. Several types of such thrusters have been investigated worldwide, and typical examples of electrodeless plasma thruster are based on the electro-thermal plasma acceleration {e.g. the Variable Specific Impulse Magnetoplasma Rocket (VASIMR) [3], [4]} or the electro-static plasma acceleration {e.g. the Helicon Double Layer Thruster (HDLT) [5]-[7]}. The plasma source of these thrusters is based on the helicon plasma discharge. The helicon plasma source is one of the radio frequency (RF) plasma production methods, which is an electrodeless plasma source. In the case of the VASIMR, ions in the plasma are heated by the ion cyclotron resonance and subsequently accelerated through a magnetic nozzle. In the case of the HDLT, plasma is accelerated by an electrical potential drop, so-called a double layer, generated by the rapid plasma expansion through the magnetic nozzle. On the other hand, the electromagnetic plasma acceleration is expected to achieve higher thrust density than the other plasma acceleration methods, and high thrust efficiency (about 50%) is also expected in the high power operation (high magnetic Reynolds number operation). Therefore, the electromagnetic plasma acceleration is suitable for the high power electric propulsion system. However, the electrodeless electromagnetic acceleration method has not been established yet.

In order to develop the electrodeless electromagnetic plasma thruster, we have initiated the HEAT (Helicon Electrodeless Advanced Thruster) project in Japan and have been investigating this propulsion system utilizing a helicon plasma source [8]-[10]. In our concepts, the high density helicon plasma passing through the magnetic nozzle is electromagnetically accelerated by additional RF power input.

Fig. 1 shows a configuration of the Lissajous acceleration-type plasma thruster, in which the additional electromagnetic plasma acceleration is produced by the RF rotating electric field (REF) [11]. In the plasma production part, a compact helicon plasma source produces a high-density plasma by applying the RF power and a static magnetic field. In the acceleration area at the downstream of the helicon plasma source, a directional REF on the cross-sectional plane is applied to the plasma using two pairs of facing antennas. The REF induces azimuthal electron currents due to the  $\mathbf{E} \times \mathbf{B}$  drift gyration motion, and the plasma flow, accelerated through the magnetic nozzle, is additionally accelerated by the Lorentz force, i.e., a product of the azimuthal electric current and the radial component of the magnetic field. The entire process can be conducted without contacts between electrodes and the plasma.

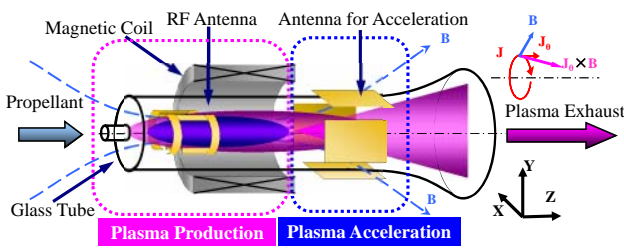

Fig. 1 Concept of Lissajous acceleration-type plasma thruster

In our previous works, high-density helicon plasma up to  $10^{19} \text{ m}^{-3}$  has been successfully produced in the laboratory-model small thruster; the glass tube of 25 mm inner diameter (I.D.) [12]. Although we observed some plasma acceleration by the REF power input, the thrust (the increment of the thrust force by the REF power is estimated to be  $76 \mu\text{N}$  using 46 mm I.D.) and the specific impulse have not reached the feasible values for the real application. For practical realization of the thruster, further intense studies are needed to optimize the design and operating parameters.

In our previous experiments, the thrust force has been estimated using the plasma plume parameters (plasma density, temperature and Mach number) obtained by the probe measurements. The thrust estimated from the plume parameters is underestimated due to the particle collisions between plasma particles and neutral particles; the momentum flux of plasma plume is reduced by the momentum transfer to the low velocity neutral particles. The direct measurement of the electromagnetic force, which acts on the magnetic circuit, can measure the pure electromagnetic force without the effect of the ion-neutral collisions. Therefore, the direct thrust measurement using a thrust stand is necessary for feasibility studies of our

thruster concepts.

In this preliminary study of the Lissajous acceleration-type plasma thruster, the direct thrust measurement of the electromagnetic thrust is conducted to clarify the basic thrust characteristics of the thruster without the REF power input (without the additional electromagnetic acceleration). In addition to the thrust measurement, the plasma parameters (electron density and electron temperature) inside the thruster are measured using an electrostatic double probe. The total thrust force and the specific impulse are estimated from the measured thrust force and the plasma parameters.

II. EXPERIMENTAL SET-UP

The direct thrust measurement is conducted using the torsion-pendulum type thrust stand. The experimental setup is shown in Fig. 2. The stand is installed within the vacuum chamber (I.D. 700 mm). The vacuum pumps evacuate the chamber down to  $10^{-3} \text{ Pa}$  or lower, and the Ar gas is fed by a mass flow controller at a predetermined mass flow rate. A schematic of the laboratory model thruster is shown in Fig. 3.

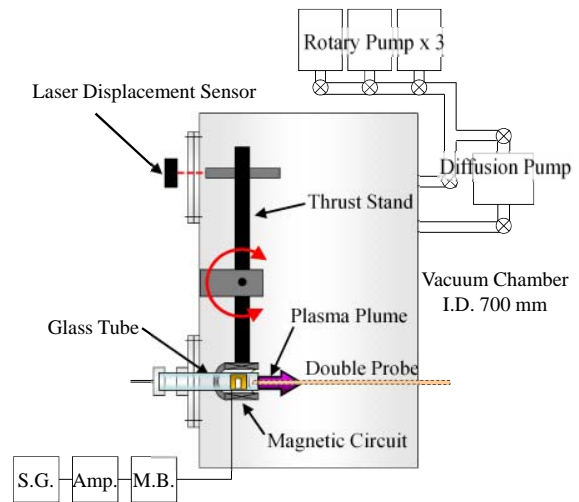

Fig. 2 Schematic of experimental setup

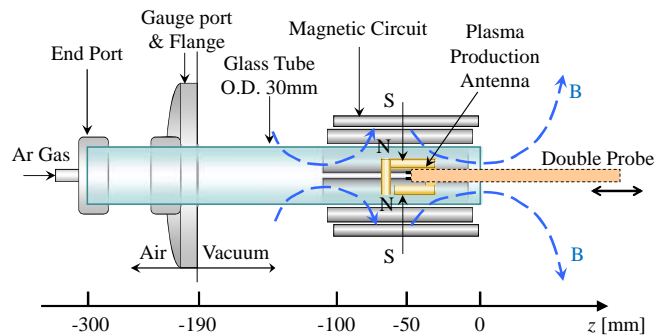

Fig. 3 Schematic of thruster configuration in thrust measurement

The thruster consists of a glass tube, a magnetic circuit and a saddle type antenna. In this experiment, the Lissajous acceleration unit (antenna for applying the REF) is not attached to the thruster. A 26 mm I.D., totally 300 mm long glass tube is

connected to a vacuum chamber (as shown in Fig. 2). A saddle type antenna (40 mm long) is used for the plasma production. The RF signal by a signal generator (Hewlett-Packard, 8648B) is amplified by a RF amplifier (Thamway, T145-5768A), and is transmitted to the antenna through a matching box (Thamway, T020-5558A). Here, the RF signal frequency for the plasma production is 27.12 MHz.

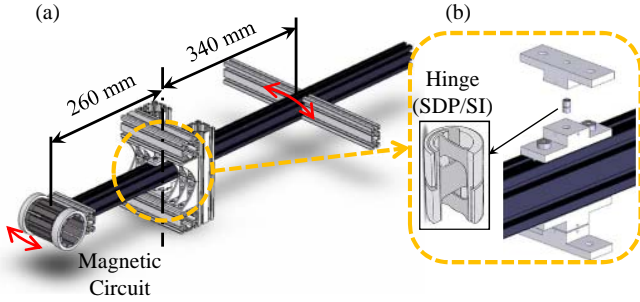

Fig. 4 Schematic of (a) torsion-pendulum type thrust stand and (b) a structure of fulcrum

In order to measure the thrust force using a simple facility, only the magnetic circuit is mounted on the thrust stand (Fig. 4) and is mechanically isolated from the other thruster components. The plasma is accelerated by the Lorentz force when the plasma passes through the magnetic nozzle. The reaction force acts on the magnetic circuit due to the diamagnetic current. Therefore, the thrust stand can measure the electromagnetic thrust force. The magnetic circuit is constructed using permanent magnets. The axial profiles of magnetic flux density are shown in Fig. 5; this field strength is enough for both the helicon plasma discharge and electromagnetic plasma acceleration. The electromagnetic force acting on the magnetic circuit results in a displacement of the pendulum arm. This arm displacement is measured by a laser displacement sensor (KEYENCE, LK-G35A), which has an accuracy of 0.5  $\mu\text{m}$ . Two hinges (SDP/SI, S99FXS018720) are used as a pivot of the pendulum. The relation between the thrust force and the displacement is calibrated by applying the repelling force using a permanent magnet and an electromagnetic coil. The repelling force is measured by the electric balance in advance. From this calibration, the sensitivity was found to be 1.3  $\mu\text{N}/\mu\text{m}$  (Fig. 6).

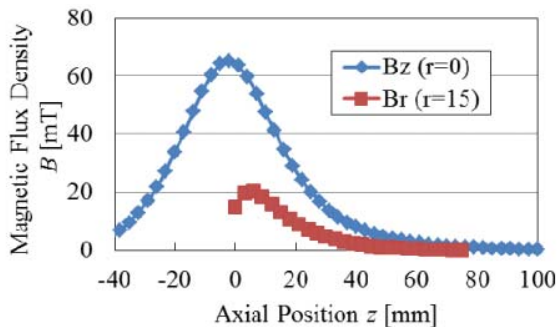

Fig. 5 Axial profiles of magnetic field  $B_z$  ( $r = 0$  mm) and  $B_r$  ( $r = 15$  mm)

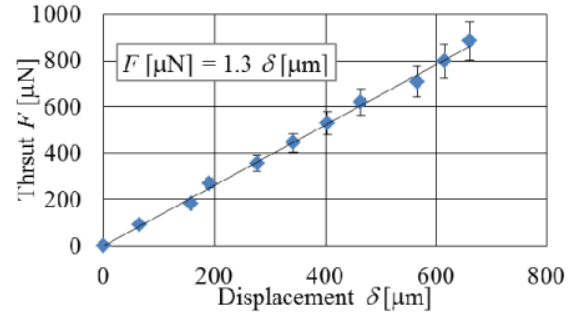

Fig. 6 Result of thrust stand calibration

The plasma parameters (electron density and the electron temperature) are measured by a double probe in the center of the plasma production area ( $z = -50$  mm,  $r = 0$  mm).

### III. EXPERIMENTAL RESULTS

Experimental conditions are shown in Table I.

TABLE I  
EXPERIMENTAL CONDITION

EXPERIMENTAL CONDITION	
Vacuum Pressure	$3.6 \times 10^{-2} \sim 1.6 \times 10^{-1}$ Pa
Ar Gas Mass Flow Rate	0.2, 0.4, 0.6, 0.8, 1.0 mg/s
Plasma Production Frequency	27.12 MHz
Plasma Production Power	100, 200, 300, 400 W
Axial Magnetic Flux Density	0.065 T

The measurement starts without the RF power input to calibrate the zero position, and the RF power is turned-on 30 s later and power is kept constant for 30 s. The data are taken until 30 seconds after turned-off the RF power. Fig. 7 shows a typical result of the time history of the pendulum displacement. The pendulum swings when the RF power is turned-on and comes back with damped oscillations to the zero position after the RF power is turned-off. The thrust force is evaluated from the difference between the mean values of the displacement with the RF power ( $t = 30$  s to 60 s in Fig. 7) and without the RF power. In the case of Fig. 7, the thrust force is evaluated as 250  $\mu\text{N}$ .

Fig. 8 shows a relation between the measured thrust and the plasma production power for various Ar gas mass flow rates. The plasma production power  $P_{\text{source}}$  is defined as a subtraction of the forward RF power and the reflection RF power. The forward power and the reflection power are measured at the RF amplifier. The thrust increases with the plasma production power and is up to 290  $\mu\text{N}$  at 400 W with a mass flow rate of 1.0 mg/s. The thrust force abruptly increases around the plasma production power of 300 W. This thrust jump may be caused by the so-called density jump, which is a typical feature of the discharge mode transition from the inductive coupled plasma to the helicon wave excited plasma. Figs. 9 and 10 plot the electron temperature and the electron density, respectively. The density jump at the plasma production power can be observed around the plasma production power of 300 W in Fig. 10. From this experimental result, the laboratory model thruster is found to generate the thrust force of sub-milli-newton even without the REF power.

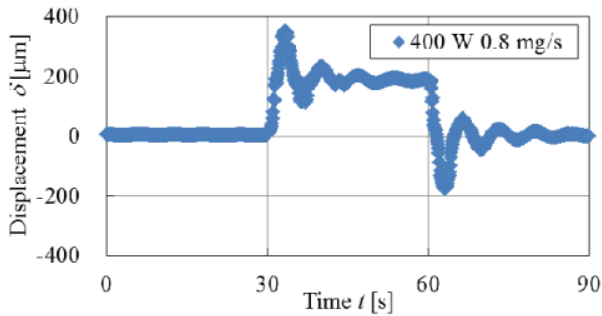

Fig. 7 Time history of pendulum displacement (plasma production power of 400 W with a RF frequency of 27.12 MHz is tuned on from  $t = 30$  s to 60 s, and the Ar gas mass flow rate is 0.8 mg/s)

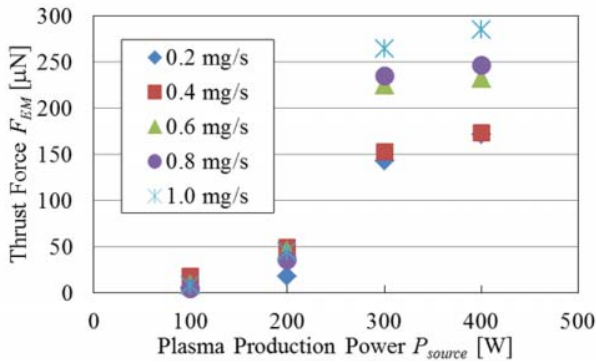

Fig. 8 Directly measured electromagnetic thrust force as a function of plasma production power

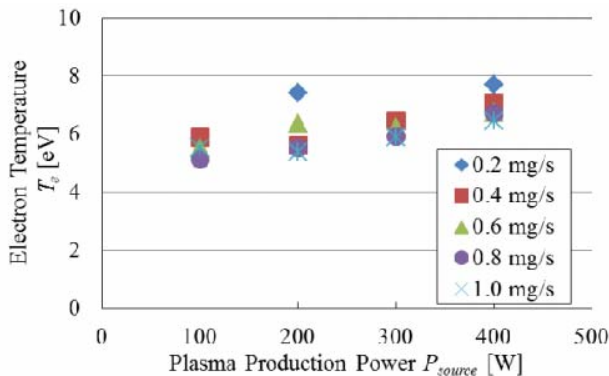

Fig. 9 Electron temperature measured by double probe as a function of plasma production power

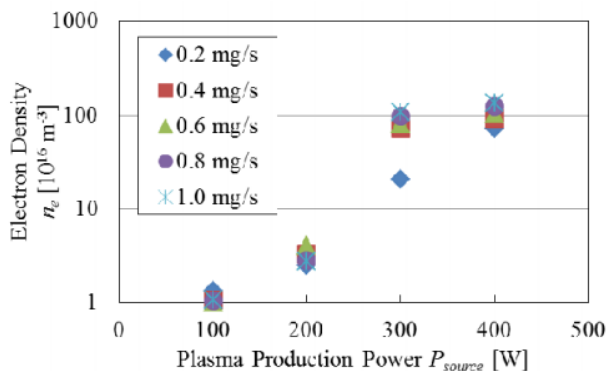

Fig. 10 Electron density measured by double probe as a function of plasma production power

#### IV. DISCUSSION

In order to evaluate the thrust performance of the thruster, the total thrust force is estimated utilizing the theoretical thrust model. There are two components in the total thrust force. One is an electromagnetic force, which is measured by the thrust stand and the other is a thrust force due to the thermal pressure, which acts on the thruster end plate. Matsuoka et al. [13] and Takahashi et al. [14], [15] have estimated the thrust force utilizing the theoretical model, and in their models, the total thrust is described by the following equation as a summation of an electromagnetic thrust  $F_{EM}$  and a thermal thrust  $F_{th}$ .

$$\begin{aligned} F_{total} &= F_{EM} + F_{th} \\ &= F_{EM} + nAk_B T_e. \end{aligned} \quad (1)$$

Here,  $n$  is the radially averaged plasma density in the center of the plasma,  $A$  is the cross-sectional area of the thruster,  $k_B$  is the Boltzmann constant and  $T_e$  is the electron temperature. By assuming the radial distribution of plasma density as  $n(r) = n_0 (1 - r^2/r_0^2)$ , the thermal thrust  $F_{th}$  is rewritten by the flowing equation. Here,  $r_0$  is the thruster cross-sectional radius.

$$F_{total} = F_{EM} + \frac{\pi}{2} n_0 r_0^2 k_B T_e. \quad (2)$$

The thermal thrust can be approximately estimated from the plasma parameters ( $n_0$  and  $T_e$ ), which are measured by the double probe. The specific impulse  $I_{sp}$  is evaluated from the total thrust force and Ar gas mass flow rate  $\dot{m}$  by the following equation. Here,  $g$  is the acceleration of gravity ( $=9.8 \text{ m/s}^2$ ).

$$I_{sp} = \frac{F_{total}}{\dot{m}g}. \quad (3)$$

In Figs. 11 and 12, the estimated total thrust force and specific impulse are plotted against  $P_{source}$ .

The total thrust force and the specific impulse increase with the plasma production power. The maximum values of the total thrust and the specific impulse are 650  $\mu\text{N}$  (plasma production power of 400 W, Ar gas mass flow rate of 1.0 mg/s) and 210 s (plasma production power of 400 W, Ar gas mass flow rate of 0.2 mg/s), respectively. The Ar gas mass flow rate with the maximum thrust is different from that with the maximum specific impulse. The high total thrust is obtained when the high Ar gas mass flow rate in the same plasma production power condition. However, the specific impulse becomes lower in the high Ar gas mass flow rate.

The total thrust and the specific impulse drastically increase with the plasma production power from 200 W to 300 W. This result indicates that the thrust performance is drastically improved by the helicon wave excitation. The maximum thrust efficiency is 0.1 % when the plasma production power of 400 W and the Ar gas mass flow rate of 0.2 mg/s. This thrust efficiency is not a feasible value for real applications. The thrust performance is expected to be improved by the thrust



enhancement using the additional REF power (Lissajous acceleration).

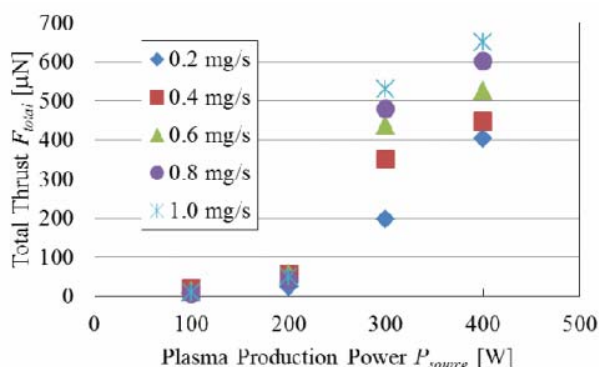

Fig. 11 Estimated total thrust force as a function of plasma production power

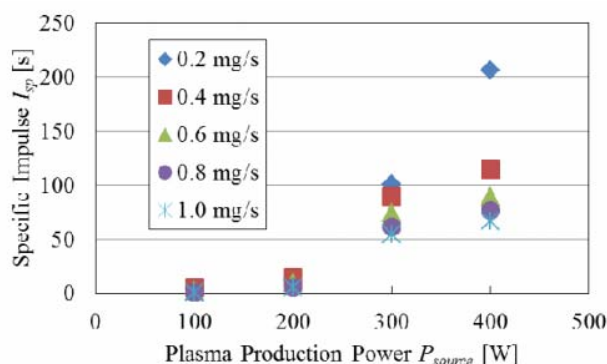

Fig. 12 Estimated specific impulse as a function of plasma production power

## V. CONCLUSION

In order to develop a long-life electric propulsion system, we have been investigating the electrodeless electromagnetic plasma thruster concept, utilizing a helicon plasma source and the Lissajous plasma acceleration. Using a laboratory model thruster, the electromagnetic thrust force acting on the magnetic circuit was directly measured by the torsion-pendulum type thrust stand under the condition without the Lissajous plasma acceleration as a preliminary study. The electromagnetic thrust force increases with the plasma production power up to 290  $\mu$ N (plasma production power of 400 W). The thrust force and the density jump are observed at a plasma production power of 300 W due to the discharge mode transition from the inductive coupled plasma to the helicon wave excited plasma. The thermal thrust was estimated from the probe measurement result, and the total thrust is estimated to be up to 650  $\mu$ N (plasma production power of 400 W, Ar gas mass flow rate of 1.0 mg/s) and estimated maximum values of the specific impulse is 210 s (plasma production power of 400 W, Ar gas mass flow rate of 0.2 mg/s).

## VI. FUTURE WORKS

The electromagnetic thrust force with the additional REF power will be evaluated using the torsion-pendulum type thrust stand. Furthermore, the parameter survey will be conducted for the thruster configuration and the REF parameters, and the feasibility of the Lissajous acceleration-type plasma thruster will be discussed comparing the experimental results and the theoretical thrust model.

## ACKNOWLEDGMENT

This work has been supported by the JSPS Grant-in-Aid for scientific research (S: 21226019).

## REFERENCES

- [1] H. Kuninaka, K. Nishiyama, I. Funaki, T. Yamada, Y. Shimizu and J. Kawaguchi, "Powered flight of electron cyclotron resonance ion engines on Hayabusa explorer," *J. Propul. Power*, Vol. 23, 3, pp. 544-551, 2007.
- [2] K. Toki, S. Shinohara, T. Tanikawa, I. Funaki and K. P. Shamrai, "Preliminary investigation of helicon plasma source for electric propulsion applications," IEPC 03-0168, 28th Int. Electric Propul. Conf., Toulouse, France, 17-21 March, 2003.
- [3] J. P. Squire, L. D. Cassady, F. R. Chang Diaz, M. D. Carter, T. G. Glover, *et al.*, "Superconducting 200 kW VASIMR experiment and integrated testing," IEPC-2009-209, 31st Int. Electric Propul. Conf., University of Michigan, USA, September 20-24, 2009.
- [4] L. D. Cassady, B. W. Longmier, C. S. Olsen, M. G. Ballenger, G. E. McCaskill, *et al.*, "VASIMR<sup>®</sup> performance results," AIAA2010-6772, 46th AIAA/ASME/SAE/ASEE Joint Propul. Conf. & Exhibit, Nashville, TN, July 25-28, 2010.
- [5] C. Charles, P. Alexander, C. Costa, O. Sutherland, R. W. Boswell, *et al.*, "Helicon double layer thrusters," IEPC-2005-290, 29th Int. Electric Propul. Conf., Princeton University, October 31 – November 4, 2005.
- [6] I. Musso, M. Manente, J. Carlsson, C. Giacomuzzo, D. Pavarin, *et al.* "2D OOPIC simulations of the helicon double layer," IEPC-2007-146, 30th Int. Electric Propul. Conf., Florence, Italy, September 17-20, 2007.
- [7] M. D. West, C. Charles and R. W. Boswell, "Testing a helicon double layer thruster immersed in a space-simulation chamber," *J. Propul. Power*, Vol. 24, 1, pp. 134-141, 2008.
- [8] K. Toki, S. Shinohara, T. Tanikawa, I. Funaki and K. P. Shamrai, "Feasibility study of electrodeless magnetoplasmadynamic acceleration," AIAA2004-3935, 40th AIAA/ASME/SAE/ASEE Joint Propul. Conf. & Exhibit, Fort, Lauderdale, FL, July 11-14, 2004.
- [9] S. Shinohara, T. Hada, T. Motomura, K. Tanaka, T. Tanikawa, *et al.*, "Development of high-density helicon plasma sources and their applications," *Phys. Plasmas*, Vol. 16, 057104, 2009.
- [10] S. Shinohara, "High-density helicon plasma sources: development and application," 11.301, 37th EPS Conference on Plasma Physics, Dublin, Ireland, June, 21-25, 2010.
- [11] H. Nishida, T. Nakamura, S. Shinohara, T. Matsuoka, I. Funaki, *et al.*, "Study on proof-of-principle of Lissajous acceleration for electrodeless helicon plasma thruster," *Frontier of Appl. Plasma Tech.*, Vol. 5, 2, 67, 2012.
- [12] K. Toki, S. Shinohara, T. Tanikawa, T. Hada, I. Funaki, *et al.*, "A compact helicon source plasma acceleration by RF antennae," JAXA-RR-09-003, *JAXA Research and Development Report*, 2010.
- [13] T. Matsuoka, I. Funaki, T. Nakamura, K. Yokoi, H. Nishida, *et al.* "Scaling laws of Lissajous acceleration for electrodeless helicon plasma thruster," *Plasma Fus. Res.*, Vol. 6, 2406103, 2011.
- [14] K. Takahashi, T. Lafleur, C. Charles, P. Alexander, R. W. Boswell, *et al.*, "Direct thrust measurement of a permanent magnet helicon double layer thruster," *Appl. Phys. Lett.*, Vol. 98, 141503, 2011.
- [15] K. Takahashi, T. Lafleur, C. Charles, P. Alexander and R. W. Boswell, "Electron diamagnetic effect on axial force in an expanding plasma: experiments and theory," *Phys. Rev. Lett.*, Vol. 107, 235001, 2011.